

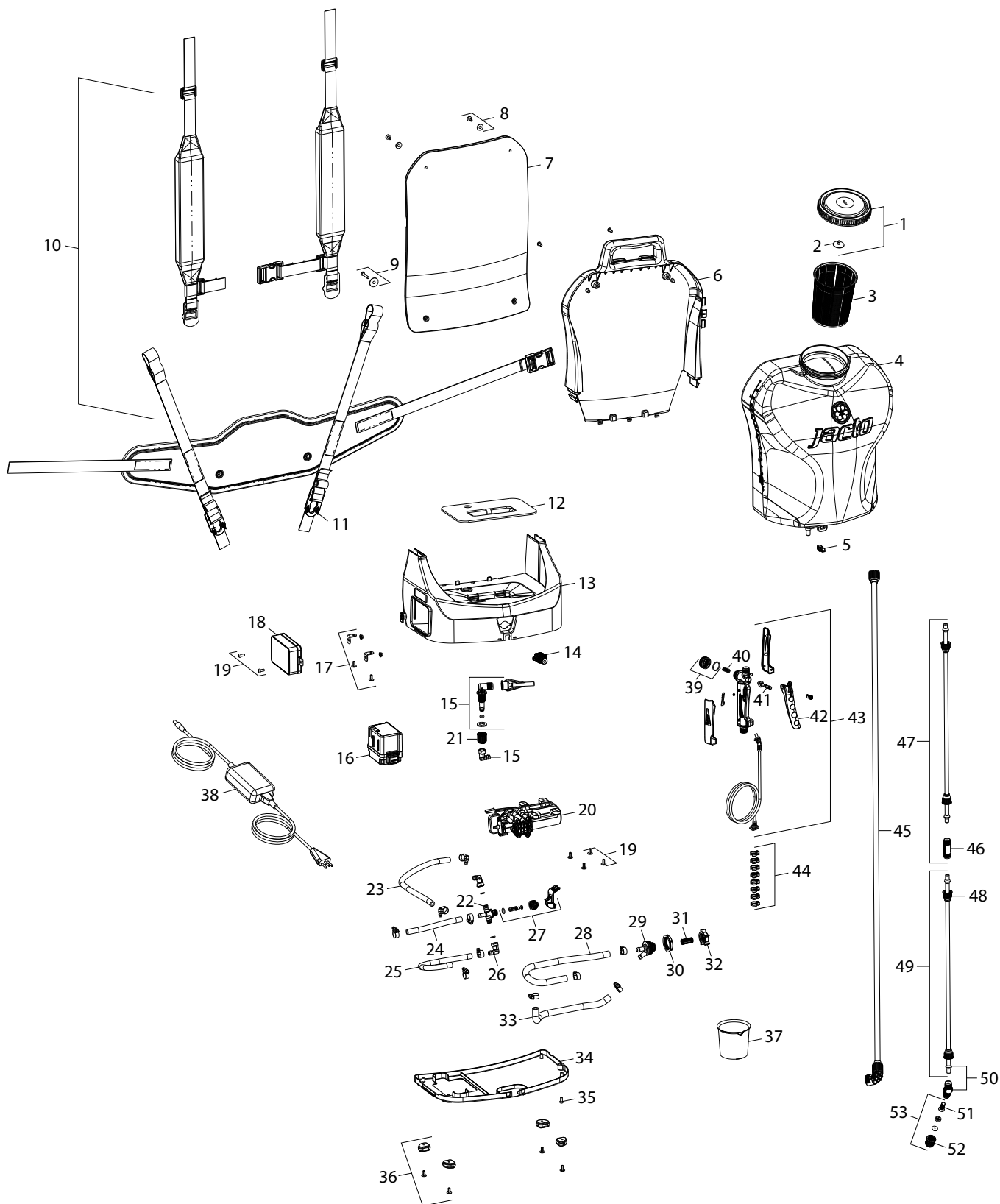

































# PARTS CATALOG

## JACTO DJB-S



















# JACTO DJB-S

Nº	CODE	DESCRIPTION	IMAGE	QTY.	UTILIZATION	NCM HS CODE	EAN BARCODE
1	1220918	LID WITH DIAPHRAGM		1	PJ, HD, PJB, DJB, DJB-S	8424.90.90	7896660888286
2	1168542	LID DIAPHRAGM (NITRILE)		1	PJ, HD, PJB, DJB, DJB-S	4016.99.90	7909436909006
3	1220919	TANK STRAINER		1	PJ, HD, PJB, DJB, DJB-S	8424.90.90	7896660888309
4	NA	TANK BODY DJB-20S		1	DJB-S	8424.90.90	7909436942249
5	1168397	BASE LOCK		1	XP, PJB, DJB, DJB-S	8424.90.90	7909436921411
6	1269555	TOP CHASSIS		1	DJB-S	8424.90.90	7909436942263
7	1269538	PADDED TANK COVER		1	DJB-S	8424.90.90	7909436940122
8	1269526	WASHER Ø6.5XØ16X1.2		1	DJB-S	7318.22.00	7909436940092
9	1269528	WASHER Ø6.5XØ24X1.2		1	DJB-S	7318.22.00	7909436940108
10	1236496	PJB/DJB DELUXE HARNESS		1	PJB, DJB, DJB-S	8424.90.90	7896660846903
11	1220973	BUCKLE		1	HD, PJB, DJB, DJB-S	8424.90.90	7909436915274
12	1269514	DJB-S BASE GASKET		1	DJB-S	4016.93.00	7909436940030
13	1269554	DJB-S LOWER FRAME		1	DJB-S	8424.90.90	7909436942256
14	1249239	CONNECTION AND SEAL		1	PJB (V2020), DJB (V2020), DJB-S	3926.90.90	7909436952590
15	1220977	AGITATOR ASSEMBLY		1	PJB, DJB, DJB-S	8424.90.90	7896660888385
16	1268737	BATTERY JB 1680		1	PJB, DJB, DJB-S	8506.50.90	7909436939010
17	1269516	PANEL SUPPORT		1	DJB-S	8424.90.90	7909436940047

Nº	CODE	DESCRIPTION	IMAGE	QTY.	UTILIZATION	NCM HS CODE	EAN BARCODE
18	1269541	DJB-S ELECTRONIC PANEL		1	DJB-S	8537.10.19	7909436940139
19	1220622	FLANGE HEAD SCREW PHILLIPS SLOT 5 X 12 MM		1	PJB, DJB, DJB-S	7318.15.00	7909436907286
20	1265961	ELECTRIC PUMP		1	PJB, DJB, DJB-S	8424.90.90	7909436937276
21	1168546	NOZZLE CAP		1	PJH, PJ, XP, HD, PJB, DJB, DJB-S	8424.90.90	7909436925310
22	1220638	AGITATOR VALVE BODY		1	PJB, DJB, DJB-S	3926.90.90	7896660890265
23	1269511	VALVE/OUTPUT HOSE		1	DJB-S	3917.39.00	7909436940016
24	1269498	VALVE/AGITATOR HOSE		1	DJB-S	3917.39.00	7909436939959
25	1269500	PUMP/VALVE HOSE		1	DJB-S	3917.39.00	7909436939935
26	1220631	SWIVEL CONNECTOR 3/8		1	PJB, DJB, DJB-S	3917.40.90	7909436922692
27	1220979	AGITATOR LEVER AND NEEDLE ASSEMBLY		1	PJB, DJB, DJB-S	8424.90.90	7896660890258
28	1269510	FILTER/PUMP HOSE		1	DJB-S	3917.39.00	7909436940009
29	1268713	BASE FILTER SUPPORT		1	DJB-S	8424.90.90	7909436938877
30	1269493	FILTER SUPPORT NUT		1	DJB-S	3926.90.90	7909436939966
31	1220634	INLINE FILTER		1	PJB, DJB, DJB-S	8421.29.90	7909436907125
32	1268710	FILTER LID		1	DJB-S	8421.99.99	7909436938754
33	1269513	TANK/FILTER HOSE		1	DJB-S	3917.39.00	7909436940023
34	1269491	LOWER FRAME COVER		1	DJB-S	8424.90.90	7909436939980







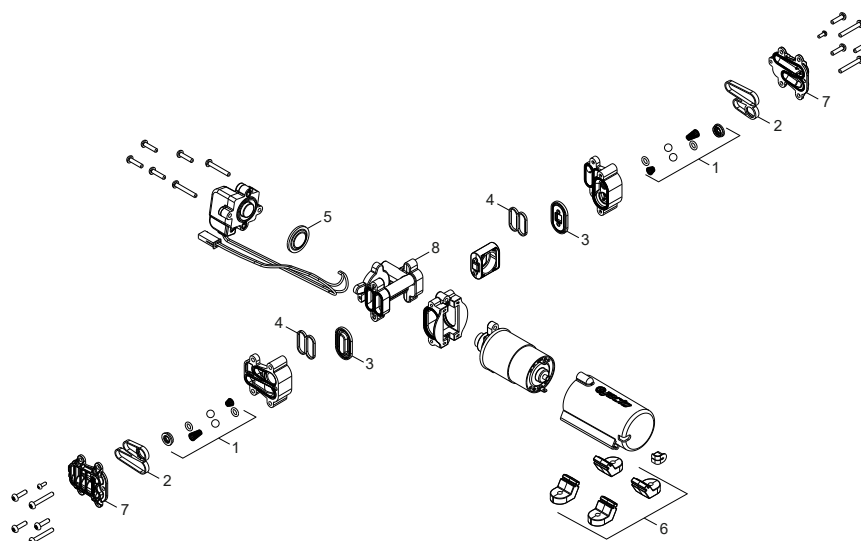

# JACTO DJB-S

Nº	CODE	DESCRIPTION	IMAGE	QTY.	UTILIZATION	NCM HS CODE	EAN BARCODE
35	1220947	PAN HEAD SCREW PHILLIPS SLOT M 5X0,8X12		1	PJB, DJB, DJB-S	7318.15.00	7909436907354
36	1220624	RUBBER FEET KIT		1	PJB, DJB, DJB-S	4016.99.90	7896660888439
37	1269524	CALIBRATION JUG 150 ML GRAD 5ML		1	DJB-S	8424.90.90	7909436940085
38	1223797	PLUG TYPE A CHARGER		1	PJB, DJB, DJB-S	8504.40.10	7896660894140
39	1168544	TRIGGER VALVE CAP AND RING		1	PJH, PJ, XP, HD, PJB, DJB, DJB-S	3926.90.90	7909436921138
40	1222660	SPRING		1	PJH, PJ, XP, HD, PJB, DJB, DJB-S	7320.90.00	7909436921022
41	1168422	NEEDLE LP-3 AND RINGS		1	PJH, PJ, XP, HD, PJB, DJB, DJB-S	8481.90.90	7899144899037
42	1269523	TRIGGER VALVE LEVER		1	DJB-S	8424.90.90	7909436940078
43	1269490	ELECTRONIC TRIGGER VALVE ASSEMBLY		1	DJB-S	8424.90.90	7909436939997
44	1269492	FASTENER KIT		1	DJB-S	8424.90.90	7909436939973
45	1269522	HOSE WITH QUICK COUPLER		1	DJB-S	3917.33.00	7909436940054
46	1222710	CONNECTION		1	PJH, PJ, XP, HD, PJB, DJB, DJB-S	8424.90.90	7896660895741
47	1222729	EXTENSION 600		1	PJH, PJ, XP, HD, PJB, DJB, DJB-S	8424.90.90	7896660895109
48	1220969	SCREW CAP 11/16		1	PJH, PJ, XP, HD, PJB, DJB, DJB-S	3926.90.90	7909436924924
49	100131	STAINLESS STEEL LANCE		1	PJH, PJ, XP, HD, PJB, DJB, DJB-S	8424.90.90	7896821501252
50	635276	JOINT AND CONE PACKING		1	PJH, PJ, XP, HD, PJB, DJB, DJB-S	3917.40.90	7909436931311
51	1168545	NOZZLE FILTER M50/60		1	PJH, PJ, XP, HD, PJB, DJB, DJB-S	8424.90.90	7896660860053

Nº	CODE	DESCRIPTION	IMAGE	QTY.	UTILIZATION	NCM HS CODE	EAN BARCODE
52	1168546	NOZZLE CAP		1	PJH, PJ, XP, HD, PJB-C, PJB, DJB, DJB-S	8424.90.90	7909436925310
53	427062	NOZZLE JD-12 ASSEMBLY		1	PJH, PJ, XP, HD, PJB-C, PJB, DJB, DJB-S	8424.90.90	7909436928052

## PUMP



Nº	CODE	DESCRIPTION	IMAGE	QTY.	UTILIZATION	NCM HS CODE	EAN BARCODE
1	1265959	VALVE AND SEALS KIT		1	PJB, DJB, DJB-S	8481.80.95	7909436944809
2	1265948	PUMP HEAD SEAL (JEP)		1	PJB, DJB, DJB-S	3926.90.90	7909436936415
3	1265943	PUMP DIAPHRAGM		1	PJB, DJB, DJB-S	3926.90.90	7909436948531
4	1265947	HEAD SEAL		1	PJB, DJB, DJB-S	3926.90.90	7909436936101
5	1265958	PRESSURE SWITCH MEMBRANE		1	PJB, DJB, DJB-S	3926.90.90	7909436936422
6	1279431	RUBBER FEET		1	PJB, DJB, DJB-S	8424.90.90	7909436952903
7	1279437	PUMP HEAD COVER (JEP)		1	PJB, DJB, DJB-S	8413.91.90	7909436953016
8	1279454	PUMP DISTRIBUTOR (JEP)		1	PJB, DJB, DJB-S	8424.90.90	7909436953023